

DESCRIPTION

- ELECTRONIC BALLAST
- ELECTRONIC TRANSFORMER
- SWITCH MODE POWER SUPPLY

FEATURES:

- LOW THERMAL RESISTANCE
- HIGH INPUT RESISTANCE
- FAST SWITCHING
- ROHS COMPLIANT

MAXIMUM RATINGS (T_c=25°C)

PARAMETER	SYMBOL	VALUE	UNIT
Drain-source Voltage	VDS	40	V
gate-source Voltage	VGS	±20	V
Continuous Drain Current	ID	80	A
Drain Current-Pulsed	IDM	315	A
Total Dissipation	PD	85	W
Junction Temperature	T _j	150	°C
Storage Temperature Range	T _{stg}	-55-150	°C
Single Pulse Avalanche Energy (L=0.5mH)	EAS	450	mJ

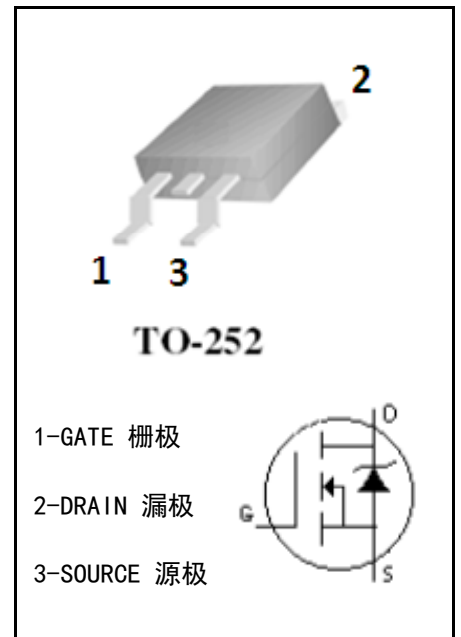
MECHANICAL

ELECTRONIC CHARACTERISTICS (T_c=25°C)

CHARACTERISTICS	SYMBOL	TEST CONDITION	MIN	MAX	UNIT
Drain-source Breakdown Voltage	BVDSS	VGS=0V, ID=250 μA	40		V
Gate Threshold Voltage	VGS (TH)	VGS=VDS, ID=250 μA	1	2.5	V
Drain-source Leakage Current	IDSS	VDS=40V, VGS=0V		1	uA
Drain-Source Diode Forward Voltage	VSD	VGS=0V, IS=10A		1.2	V
Gate-body Leakage Current (VDS = 0)	IGSS	VGS=±20V		±100	nA
Static Drain-source On Resistance	RDS (ON)	VGS=4.5V, ID=10A		10	mΩ
		VGS=10V, ID=20A		7	mΩ
Thermal Resistance Junction-case	RthJ-c			1.65	°C/W

■ DYNAMIC CHARACTERISTICS (T_c=25°C)

CHARACTERISTICS	SYMBOL	TEST CONDITION	MIN	TYP	MAX	UNIT
Input Capacitance	C _{iss}	V _{DS} =20V, V _{GS} =0V, f=1.0MHz	-	2350	-	pF
output Capacitance	C _{oss}		-	495	-	pF
Reverse Transfer Capacitance	C _{rss}		-	140	-	pF

■ SWITCHING CHARACTERISTICS (T_c=25°C)

CHARACTERISTICS	SYMBOL	TEST CONDITION	MIN	TYP	MAX	UNIT
Turn-On Delay Time	t _{d(on)}	V _{DD} =20V, I _D =2A, R _L =1Ω V _{GS} =10V, R _G =3Ω	-	11	-	ns
Turn-On Rise Time	t _r		-	10	-	ns
Turn-Off Delay Time	t _{d(off)}		-	45	-	ns
Turn-Off Rise Time	t _f		-	20	-	ns
Total Gate Charge	Q _g	V _{DS} =20V, I _D =20A, V _{GS} =10V	-	39	-	nC
Gate-Source Charge	Q _{gs}		-	9	-	nC
Gate-Drain Charge	Q _{gd}		-	11	-	nC

■ DRAIN-SOURCE DIODE MAXIMUM RATINGS AND CHARACTERISTICS (T_c=25°C)

CHARACTERISTICS	SYMBOL	TEST CONDITION	MIN	TYP	MAX	UNIT
Diode Forward Voltage	V _{SD}	V _{GS} =0V, I _S =10A	-	-	1.2	V
Reverse Recovery Time	t _{rr}	T _J =25°C, I _F =20A, di/dt=100A/μs	-	32	-	ns
Reverse Recovery Charge	Q _{rr}		-	35	-	nC

CHARACTERISTICS CURVE

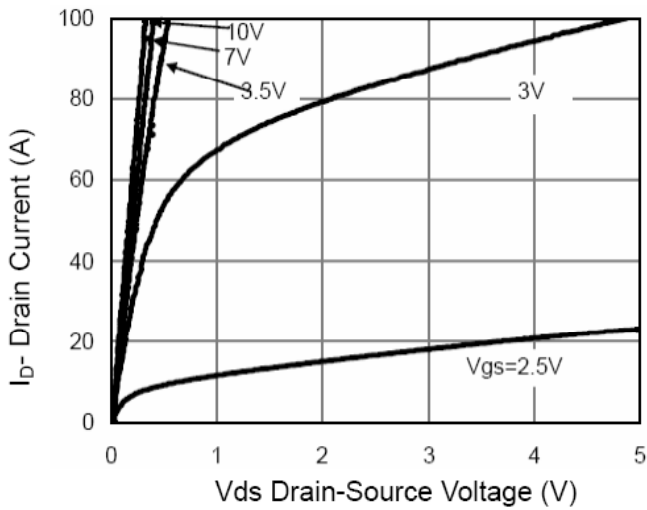

Output Characteristic

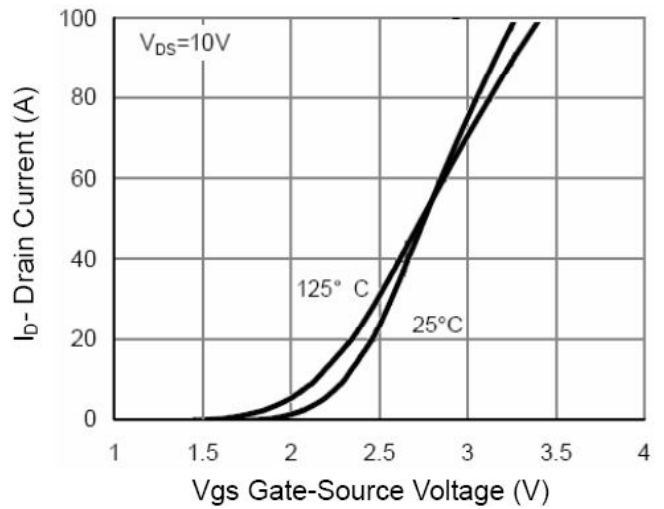

Transfer Characteristic

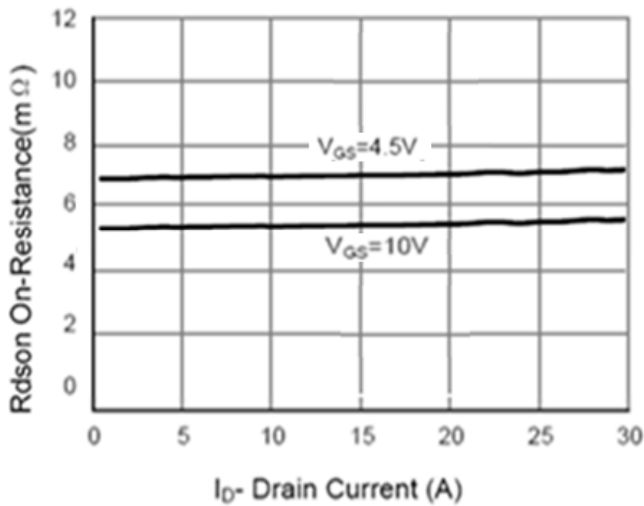

On Resistance Vs Drain Current

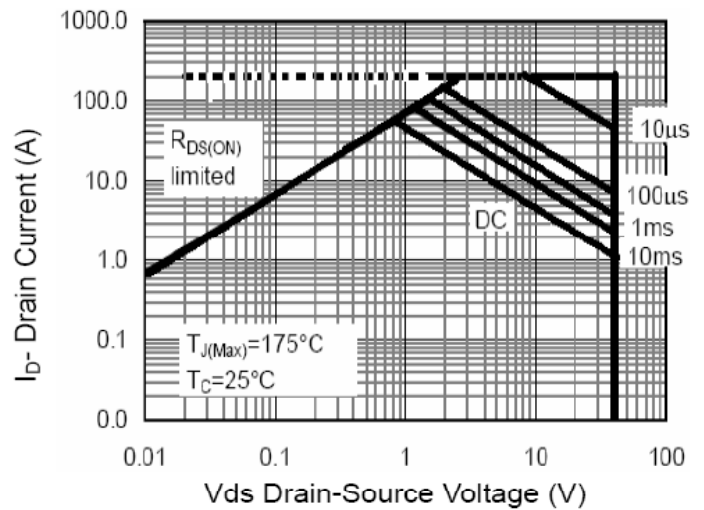

Safe Operation Area

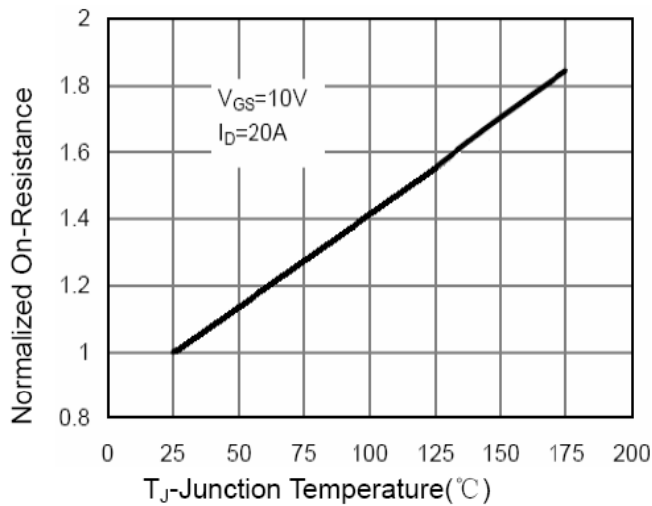

On Resistance Vs Junction Temperature

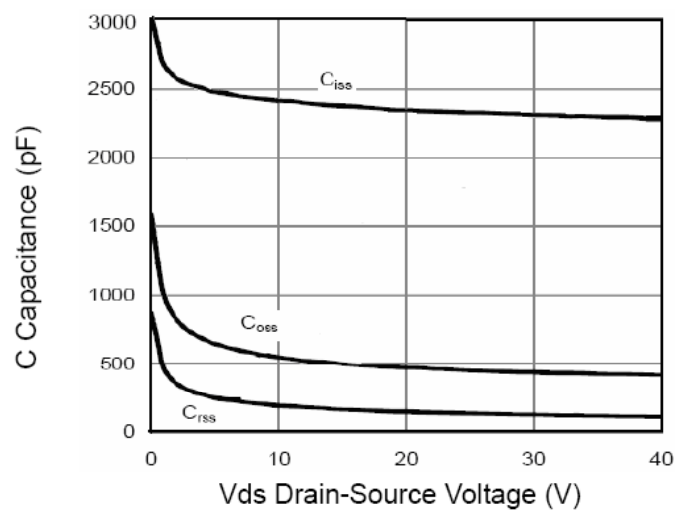

Capacitance

CHARACTERISTICS CURVE

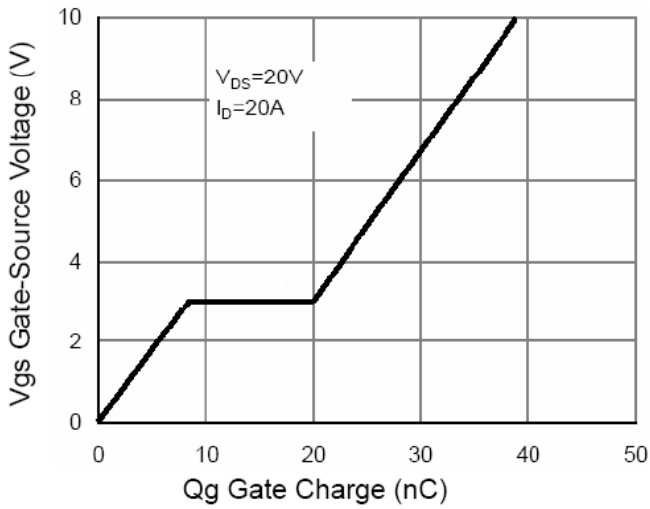

Gate Charge Waveform

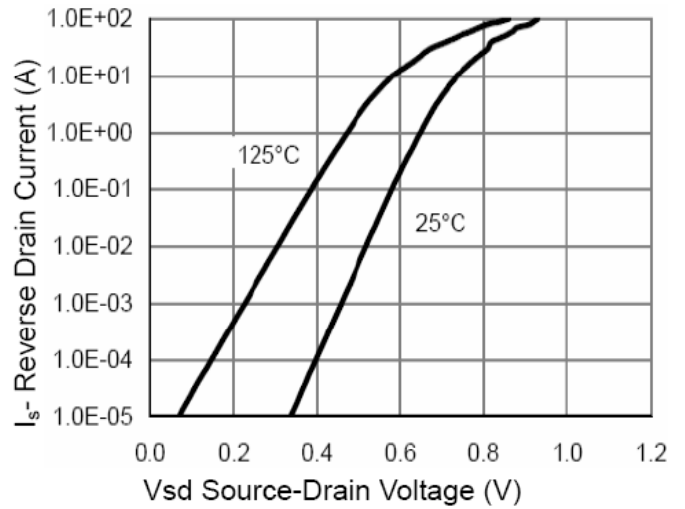

Source-Drain Diode Forward Voltage

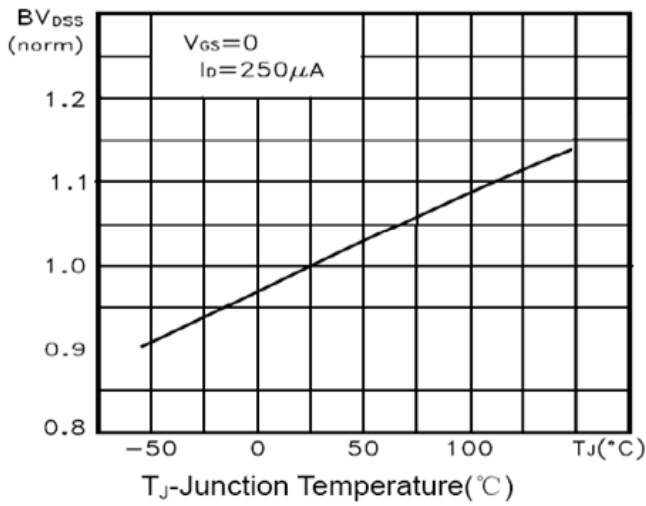

Breakdown Voltage Vs Junction Temperature

TO-252 MECHANICAL DATA

UNIT: mm

SYMBOL	MIN	NOM	MAX	SYMBOL	MIN	NOM	MAX
A	2.10		2.50	E	5.80		6.30
B	0.80		1.25	e1	2.25	2.30	2.35
b	0.50		0.85	e2	4.45		4.75
b1	0.50		0.90	L1	9.50		10.20
b2	0.45		0.60	L2	0.90		1.45
C	0.45		0.60	L3	0.60		1.10
D	6.35		6.75	K	-0.1		0.10
D1	5.10		5.50				

